

catit.

# VESPER MINOU

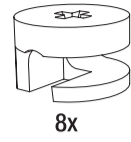

CATIT.COM

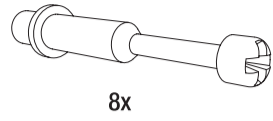
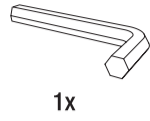

VESPER MINOU

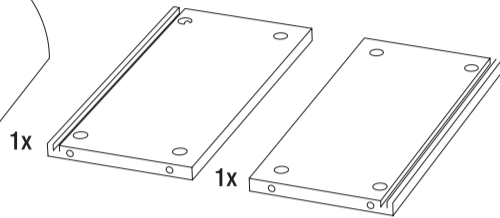
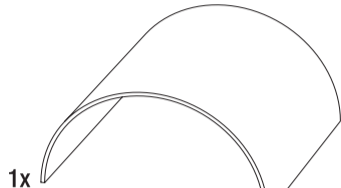
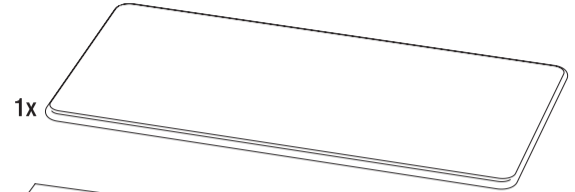
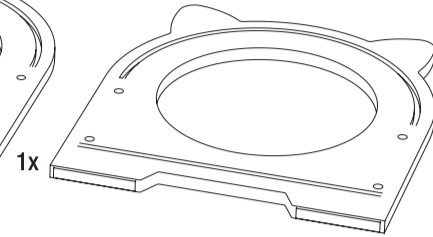
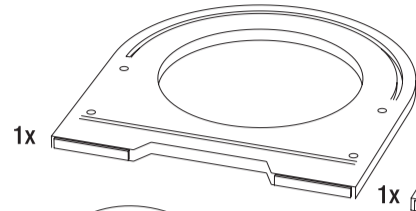
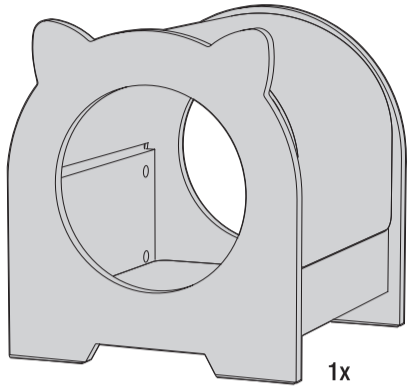

1x

